



ТОКАРНАЯ
ОБРАБОТКА



2012

SCLCR/L

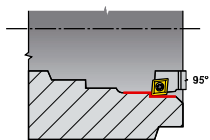

SRSCR/L

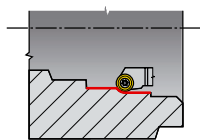

SSKCR/L

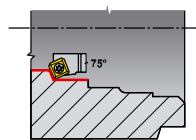

SSRCR/L

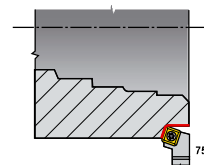

SSSCR/L

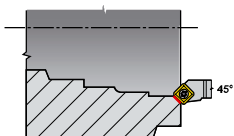

STFCR/L

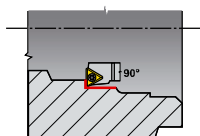

STGCR/L

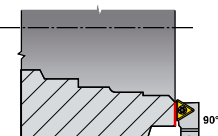

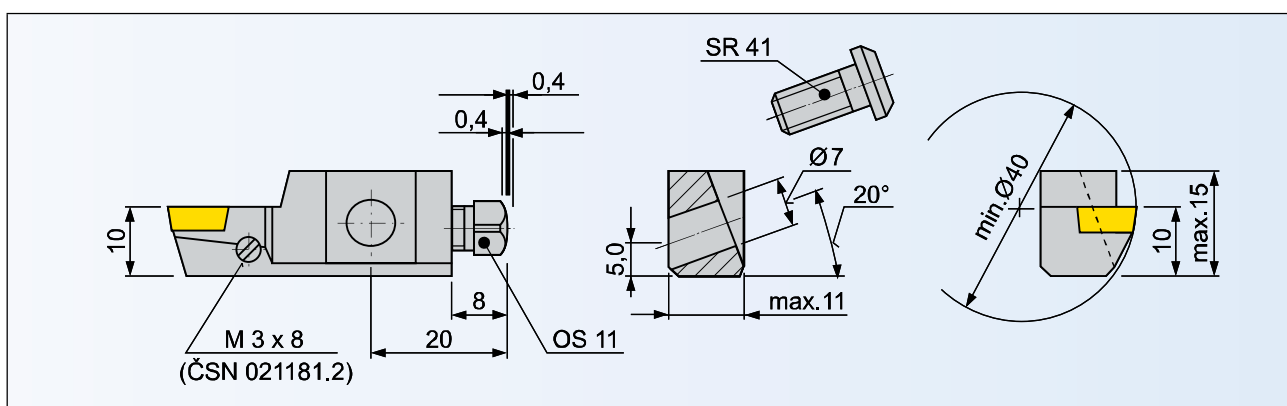
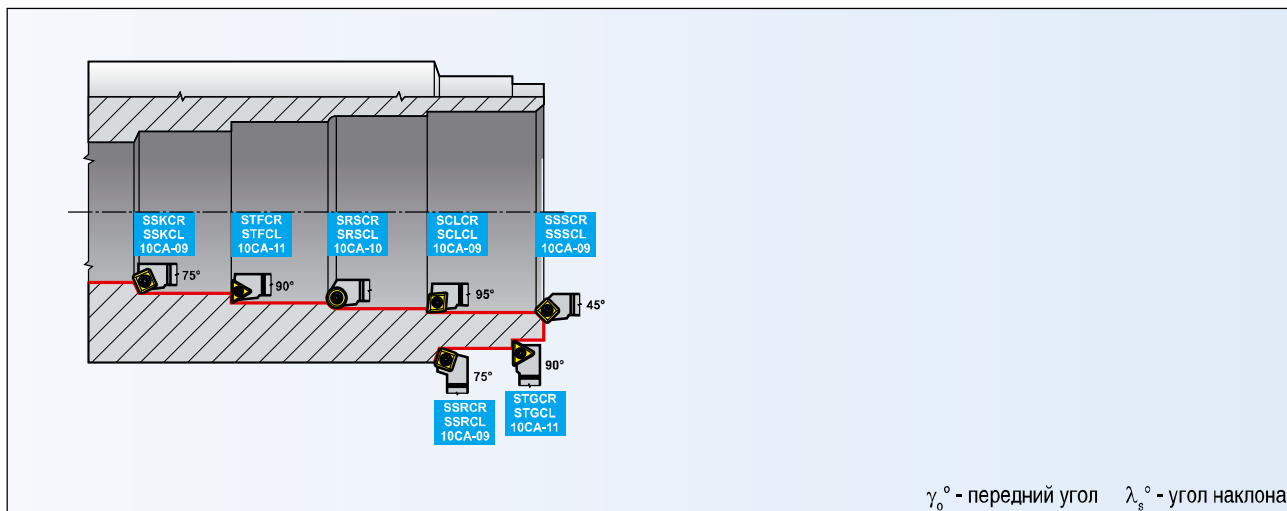

РЕЗЦОВЫЕ ВСТАВКИ

ISO	П/Л	[кг]	Запчасти	Пластины		
SCLCR/L 10 CA-09	● / ○	0,06	SO4	CC.. 09T3..		145-147
SRSCR/L 10 CA-10	○ / ○	0,06	SO4	FC.. 10T3MO		161-164
SSKCR/L 10 CA-09	● / ○	0,06	SO4	SC.. 09T3..		167-168
SSSCR/L 10 CA-09	○ / ○	0,06	SO4	SC.. 09T3..		167-168
SSRCL/L 10 CA-09	○ / ○	0,06	SO4	SC.. 09T3..		167-168
STFCR/L 10 CA-11	● / ○	0,06	SO1	TC.. 1102..		175-177
STGCR/L 10 CA-11	○ / ○	0,06	SO1	TC.. 1102..		175-177

ЗАПАСНЫЕ ЧАСТИ

Тип	Зажимной винт*	Резьба	Опорная пластина	Специальный винт	Отвертка	Ключ
SO1	US 2506-T07P	(M2,5x6,3)	-	-	FLAG T07P	-
SO4	US 3508-T15P	(M3,5x8,5)	-	-	FLAG T15P	-

● складуемый ассортимент ○ нескладуемый ассортимент
Актуальный ассортимент представлен в действующем прайс-листе.

все размеры в [мм]

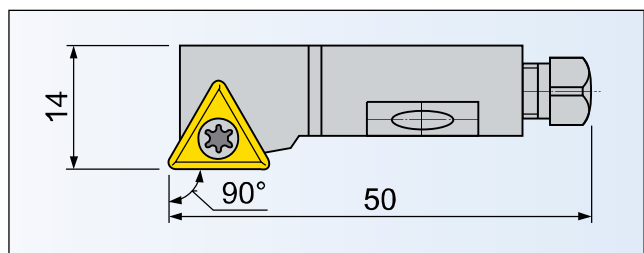
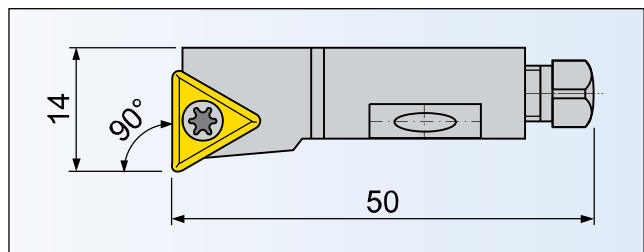
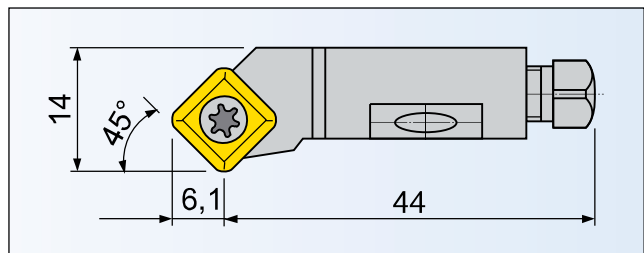
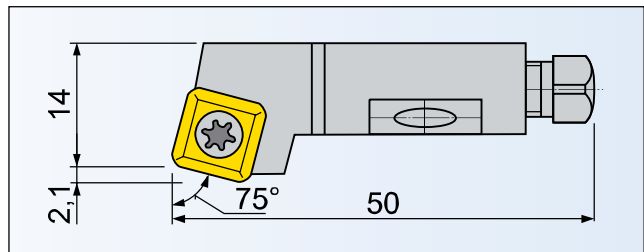
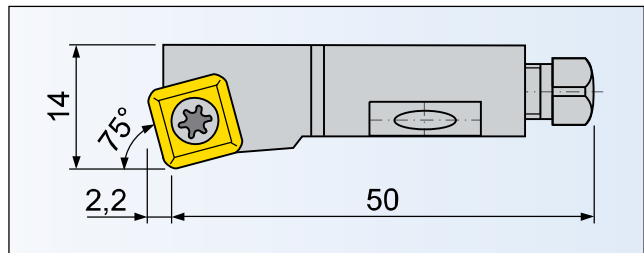
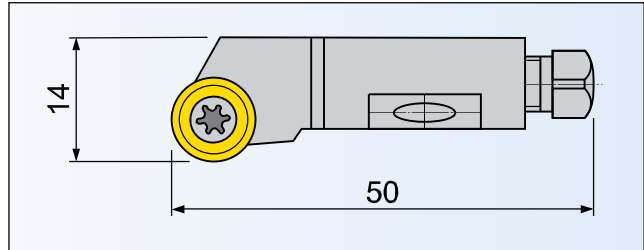
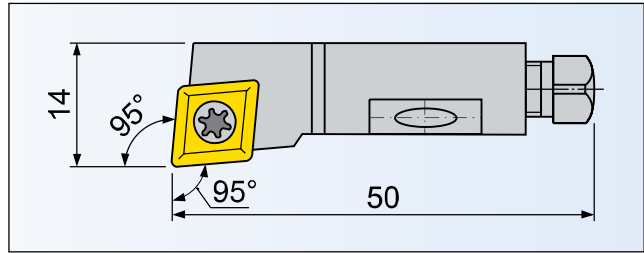

ISO S